



Model 682A02

DIN rail mount ICP® signal conditioner, 24 VDC input

Installation and Operating Manual

**For assistance with the operation of this product,
contact the PCB Piezotronics, Inc.**

Toll-free: 716-684-0001

24-hour SensorLine: 716-684-0001

Fax: 716-684-0987

E-mail: info@pcb.com

Web: www.pcb.com



Repair and Maintenance

PCB guarantees Total Customer Satisfaction through its “Lifetime Warranty Plus” on all Platinum Stock Products sold by PCB and through its limited warranties on all other PCB Stock, Standard and Special products. Due to the sophisticated nature of our sensors and associated instrumentation, **field servicing and repair is not recommended and, if attempted, will void the factory warranty.**

Beyond routine calibration and battery replacements where applicable, our products require no user maintenance. Clean electrical connectors, housings, and mounting surfaces with solutions and techniques that will not harm the material of construction. Observe caution when using liquids near devices that are not hermetically sealed. Such devices should only be wiped with a dampened cloth—never saturated or submerged.

In the event that equipment becomes damaged or ceases to operate, our Application Engineers are here to support your troubleshooting efforts 24 hours a day, 7 days a week. Call or email with model and serial number as well as a brief description of the problem.

Calibration

Routine calibration of sensors and associated instrumentation is necessary to maintain measurement accuracy. We recommend calibrating on an annual basis, after exposure to any extreme environmental influence, or prior to any critical test.

PCB Piezotronics is an ISO-9001 certified company whose calibration services are accredited by A2LA to ISO/IEC 17025, with full traceability to SI through N.I.S.T. In addition to our standard calibration services, we also offer specialized tests, including: sensitivity at elevated or cryogenic temperatures, phase response, extended high or low frequency response, extended range, leak testing, hydrostatic pressure testing, and others. For more information, contact your local PCB Piezotronics distributor, sales representative, or factory customer service representative.

Returning Equipment

If factory repair is required, our representatives will provide you with a Return Material Authorization (RMA) number, which we use to reference any information you have already provided and expedite the repair process. This number should be clearly marked on the outside of all returned package(s) and on any packing list(s) accompanying the shipment.

Contact Information

PCB Piezotronics, Inc.
3425 Walden Ave.
Depew, NY14043 USA
Toll-free: (800) 828-8840
24-hour SensorLine: (716) 684-0001
General inquiries: info@pcb.com
Repair inquiries: rma@pcb.com

For a complete list of distributors, global offices and sales representatives, visit our website, www.pcb.com.

Safety Considerations

This product is intended for use by qualified personnel who recognize shock hazards and are familiar with the precautions required to avoid injury. While our equipment is designed with user safety in mind, the protection provided by the equipment may be impaired if equipment is used in a manner not specified by this manual.

Discontinue use and contact our 24-Hour Sensorline if:

- Assistance is needed to safely operate equipment
- Damage is visible or suspected
- Equipment fails or malfunctions

For complete equipment ratings, refer to the enclosed specification sheet for your product.

Definition of Terms and Symbols

The following symbols may be used in this manual:



DANGER

Indicates an immediate hazardous situation, which, if not avoided, may result in death or serious injury.

**CAUTION**

Refers to hazards that could damage the instrument.

**NOTE**

Indicates tips, recommendations and important information. The notes simplify processes and contain additional information on particular operating steps.

The following symbols may be found on the equipment described in this manual:



This symbol on the unit indicates that high voltage may be present. Use standard safety precautions to avoid personal contact with this voltage.



This symbol on the unit indicates that the user should refer to the operating instructions located in the manual.



This symbol indicates safety, earth ground.



PCB工业监视和测量设备 - 中国RoHS2公布表

PCB Industrial Monitoring and Measuring Equipment - China RoHS 2 Disclosure Table

部件名称	有害物质					
	铅 (Pb)	汞 (Hg)	镉 (Cd)	六价铬 (Cr(VI))	多溴联苯 (PBB)	多溴二苯醚 (PBDE)
住房	0	0	0	0	0	0
PCB板	X	0	0	0	0	0
电气连接器	0	0	0	0	0	0
压电晶体	X	0	0	0	0	0
环氧	0	0	0	0	0	0
铁氟龙	0	0	0	0	0	0
电子	0	0	0	0	0	0
厚膜基板	0	0	X	0	0	0
电线	0	0	0	0	0	0
电缆	X	0	0	0	0	0
塑料	0	0	0	0	0	0
焊接	X	0	0	0	0	0
铜合金/黄铜	X	0	0	0	0	0
本表格依据 SJ/T 11364 的规定编制。						
0：表示该有害物质在该部件所有均质材料中的含量均在 GB/T 26572 规定的限量要求以下。						
X：表示该有害物质至少在该部件的某一均质材料中的含量超出 GB/T 26572 规定的限量要求。						
铅是欧洲RoHS指令2011/65/ EU附件三和附件四目前由于允许的豁免。						

CHINA RoHS COMPLIANCE

Component Name	Hazardous Substances					
	Lead (Pb)	Mercury (Hg)	Cadmium (Cd)	Chromium VI Compounds (Cr(VI))	Polybrominated Biphenyls (PBB)	Polybrominated Diphenyl Ethers (PBDE)
Housing	O	O	O	O	O	O
PCB Board	X	O	O	O	O	O
Electrical Connectors	O	O	O	O	O	O
Piezoelectric Crystals	X	O	O	O	O	O
Epoxy	O	O	O	O	O	O
Teflon	O	O	O	O	O	O
Electronics	O	O	O	O	O	O
Thick Film Substrate	O	O	X	O	O	O
Wires	O	O	O	O	O	O
Cables	X	O	O	O	O	O
Plastic	O	O	O	O	O	O
Solder	X	O	O	O	O	O
Copper Alloy/Brass	X	O	O	O	O	O

This table is prepared in accordance with the provisions of SJ/T 11364.

O: Indicates that said hazardous substance contained in all of the homogeneous materials for this part is below the limit requirement of GB/T 26572.

X: Indicates that said hazardous substance contained in at least one of the homogeneous materials for this part is above the limit requirement of GB/T 26572.

Lead is present due to allowed exemption in Annex III or Annex IV of the European RoHS Directive 2011/65/EU.

PRODUCT SPECIFIC NOTES

Model 682A02

Description:

The Model 682A02 is a Din-Rail mountable, ICP® signal conditioner. Internally, it has jumpers for selections of gain and current. The gain is selectable between 1, 10, and 100; and the current of 4 or 10 mA is also jumper selectable. The unit is powered externally from a 24 VDC power supply. All connections are easily made using terminal strips on the sides of the unit.

Installation and Operation:

1) Installation:

The unit snaps onto a 35 mm Din Rail for easy installation. Wires are attached by sliding a stripped conductor end into the terminal and securing in place by tightening the appropriate screw with a small screwdriver.

The jumpers can be adjusted by prying open the enclosure and moving the jumpers to the proper position for desired gain and constant current. When opening the unit, be careful not to damage the enclosure or the internal electronics. Refer to Section 3 for proper jumper selection.

2) Wiring, Terminal Strip:

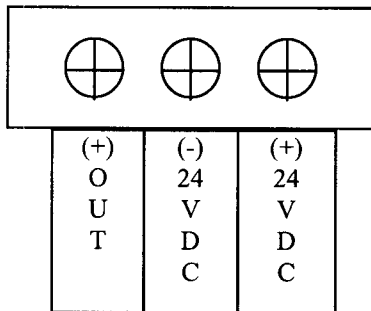

- (+) **OUT:** Sensor Positive Output Signal
- (-) **24 VDC:** Negative 24 Volt Supply
- (+) **24 VDC:** Positive 24 Volt Supply

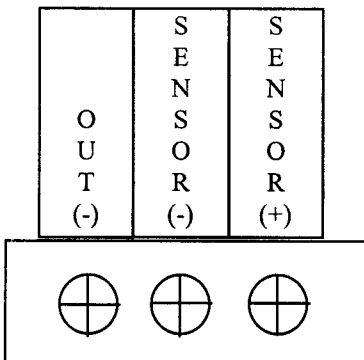

- (-) **Out:** Sensor Negative Output Signal
- (-) **Sensor:** Sensor Negative Input

(+) **Sensor:** Sensor Positive Input

3) Internal Jumper Locations:

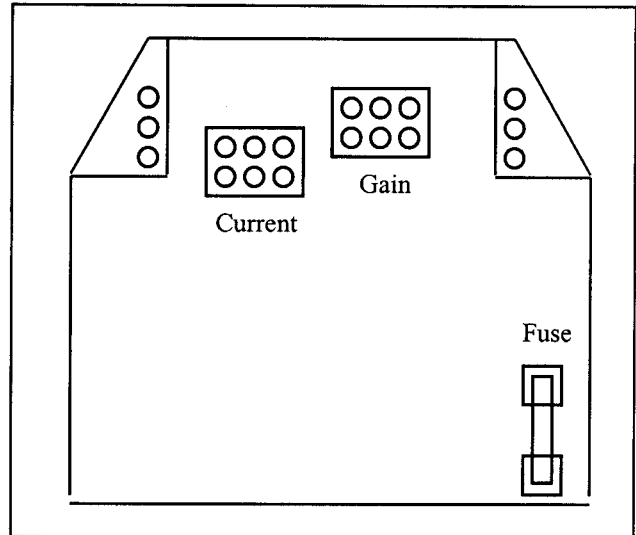

Fig. 1: Top View of Circuit Board

Jumper Configurations:

Current Selection



4 mA jumper configuration

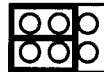

10 mA jumper configuration

Gain Selection

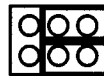

Gain of 1 jumper configuration



Gain of 10 jumper configuration

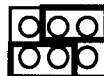

Gain of 100 jumper configuration

4) Calibration:

Units are factory set with a gain of 1 and a current of 4 mA. If there are any questions concerning the products, please contact the factory.

Model Number
682A02

ICP® SIGNAL CONDITIONER

Revision: A
ECN #: 15998

ELECTRICAL CHARACTERISTICS

	ENGLISH	SI	
Excitation Voltage (±1 VDC)	18 VDC	18 VDC	[1]
Excitation Current (±1 mA)	4/10 mA	4/10 mA	[2]
Voltage Gain	1/10/100	1/10/100	[2]
Amplitude Linearity	≤2%	≤2%	
Frequency Response (±1 dB)	60 - 6,000,000 cpm	60 - 6 000 000 cpm	[3]
Noise, Gain 1:			
Broadband Electrical Noise (1-10 kHz)	50 µV	50 µV	[4]
Spectral Noise (@ 10 mA):			
10 Hz	0.8 µV/√Hz	0,8 µV/√Hz	[4]
100 Hz	0.5 µV/√Hz	0,5 µV/√Hz	[4]
1 kHz	0.5 µV/√Hz	0,5 µV/√Hz	[4]
10 kHz	0.6 µV/√Hz	0,6 µV/√Hz	[4]
Noise, Gain 10:			
Broadband Electrical Noise (1-10 kHz)	400 µV	400 µV	[4]
Spectral Noise (@ 10 mA):			
10 Hz	7.5 µV/√Hz	7,5 µV/√Hz	[4]
100 Hz	3.6 µV/√Hz	3,6 µV/√Hz	[4]
1 kHz	3.2 µV/√Hz	3,2 µV/√Hz	[4]
10 kHz	6.0 µV/√Hz	6,0 µV/√Hz	[4]
Noise, Gain 100:			
Broadband Electrical Noise (1-10 kHz)	3.5 mV	3,5 mV	[4]
Spectral Noise (@ 10 mA):			
10 Hz	80 µV/√Hz	80 µV/√Hz	[4]
100 Hz	40 µV/√Hz	40 µV/√Hz	[4]
1 kHz	32 µV/√Hz	32 µV/√Hz	[4]
10 kHz	50 µV/√Hz	50 µV/√Hz	[4]

POWER REQUIREMENTS

Voltage (±10%)	24 VDC	24 VDC
Current (maximum)	60 mA	60 mA
Fuse	1 A	1 A

ENVIRONMENTAL CHARACTERISTICS

Temperature Range	32 to 158 °F	0 to 70 °C
-------------------	--------------	------------

PHYSICAL CHARACTERISTICS

Size	3.1 x 3.3 x 0.97	78,7 x 83,8 x 24,6 mm
Weight	0.194 lb	0,088 kg
Mounting	Din Rail	Din Rail
Input/Output Connector	Terminal Strip	Terminal Strip

OPTIONAL VERSIONS

Optional versions have identical specifications and accessories as listed for the standard model except where noted below. More than one option may be used.

-None-

NOTES:

- [1] If unit is used in conjunction with a sensor having a bias over 13 VDC, full scale output may be affected or sensor may not power up.
- [2] Internally jumper selectable.
- [3] 1 Hz = 60 cpm (cycles per minute).
- [4] Typical value.

SUPPLIED ACCESSORIES:

None

All specifications are at room temperature unless otherwise specified.

ICP® is a registered trademark of PCB Piezotronics, Inc.

In the interest of constant product improvement, we reserve the right to change specifications without notice.

Form DD030 Rev.E 2/20/98

Drawn: <i>[Signature]</i>	Engineer: <i>[Signature]</i>	Sales: <i>[Signature]</i>	Approved: <i>[Signature]</i>	Spec Number:
Date: 9/9/02	Date: 9/9/02	Date: 9/9/02	Date: 9/9/02	9702



3425 Walden Avenue, Depew, NY 14043

800-959-4464

Fax (716) 684-3823

E-Mail: imisales@pcb.com

9669

PCB Piezotronics Inc. claims proprietary rights in the information disclosed hereon. Neither it nor any reproduction thereof will be disclosed to others without written consent of PCB Piezotronics Inc.

APPLICATION		
NEXT ASS'Y	USED ON	VAR

REVISIONS				
REV	DESCRIPTION	ECN	DATE	APP'D

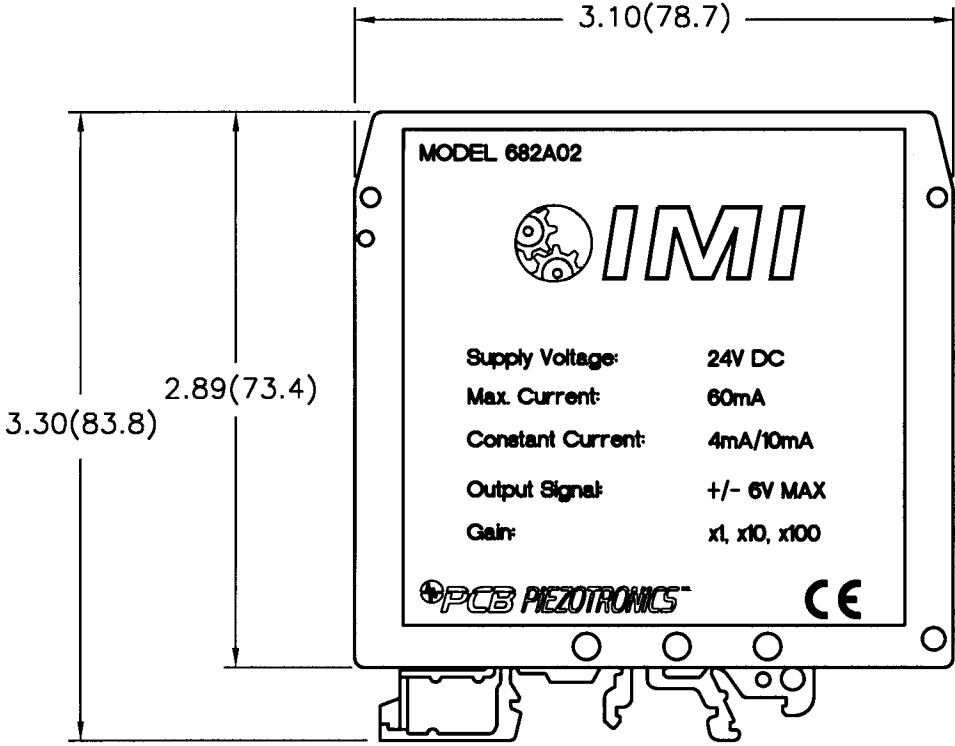
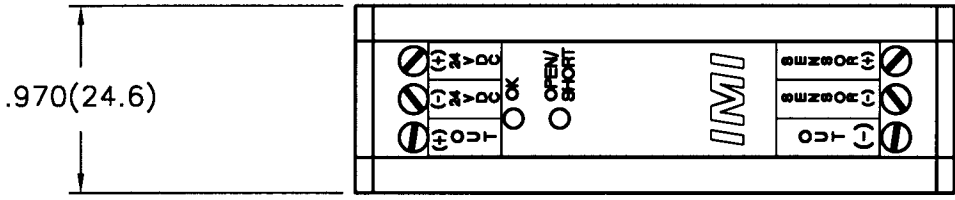

UNLESS SPECIFIED TOLERANCES		DRAWN	TW	11/3/98	MFG	R.D	11/4/98	 3425 WALDEN AVE. DEPEW, NY 14043 (716) 684-0001 EMAIL: SALES@PCB.COM	
DIMENSIONS IN INCHES	DIMENSIONS IN MILLIMETERS (IN PARENTHESIS)	CHK'D	DM	11/5/98	ENGR	TC	11/4/98		
DECIMALS XX ±.01 XXX ±.005 ANGLES ±2 DEGREES	DECIMALS XX ±0.3 XXX ±0.13 ANGLES ±2 DEGREES	APP'D	U.F	11/5/98		TC	11/4/98		
FILLET AND RADII .003 - .005	FILLET AND RADII (0.07 - 0.13)	TITLE						CODE IDENT. NO.	DWG. NO.
DD011 REV. B 03/13/98		OUTLINE DRAWING MODEL 682A02 SIGNAL CONDITIONER						52681	9669
								SCALE: FULL	SHEET 1 OF 1